

## DIP200 lens - accessories to DIP200 sensors



### Summary

A communicative motion and light sensor DIP200 should be covered with some type of the interchangeable lenses. Each lens provides different coverage areas which vary with mounting height.

Type	Lens	Shape	Mounting Height		Coverage Diameter
<b>A</b>	Standard	Cone	2.4 - 4.5 m	8 - 15 ft.	2 x height
<b>B</b>	Extra Wide	Cone	2.4 - 3.0 m	8 - 10 ft.	6 x height
<b>C</b>	High Bay	Cone	4.5 - 9.0 m	15 - 30 ft.	3 x height
<b>D</b>	Standard	Round flat	2.4 - 6.0 m	8 - 20 ft.	2 x height
<b>F</b>	Extra Wide	Dome	2.4 - 6.0 m	8 - 20 ft.	4 x height
<b>G</b>	Aisle way	Arch	2.4 - 12.0 m	8 – 40 ft.	3 x height

### Notes

The specified detection coverage and mounting height of each lens are based on the test result of human motion walking across the detection zones.

Lens G can be rotated to change the direction of coverage. Its 3X height coverage refers only to the total length, the width of coverage will vary with the mounting height (see table of Lens G section). This lens is not IP-66 rated.

Lens C/G may be mounted up to 12/15m (40/50 ft.) or higher at the area, providing with large moving object such as forklift trucks. Before installing all sensors, please ensure that the sensor can have optimal detection at desired height.

High ambient temperature (above 28°C/82°F) could reduce the coverage of PIR sensor. If ambient temperature at the covered area are expected to be high sometimes, consider adding more sensors or reduce the mounting height, if possible.

## Types overview

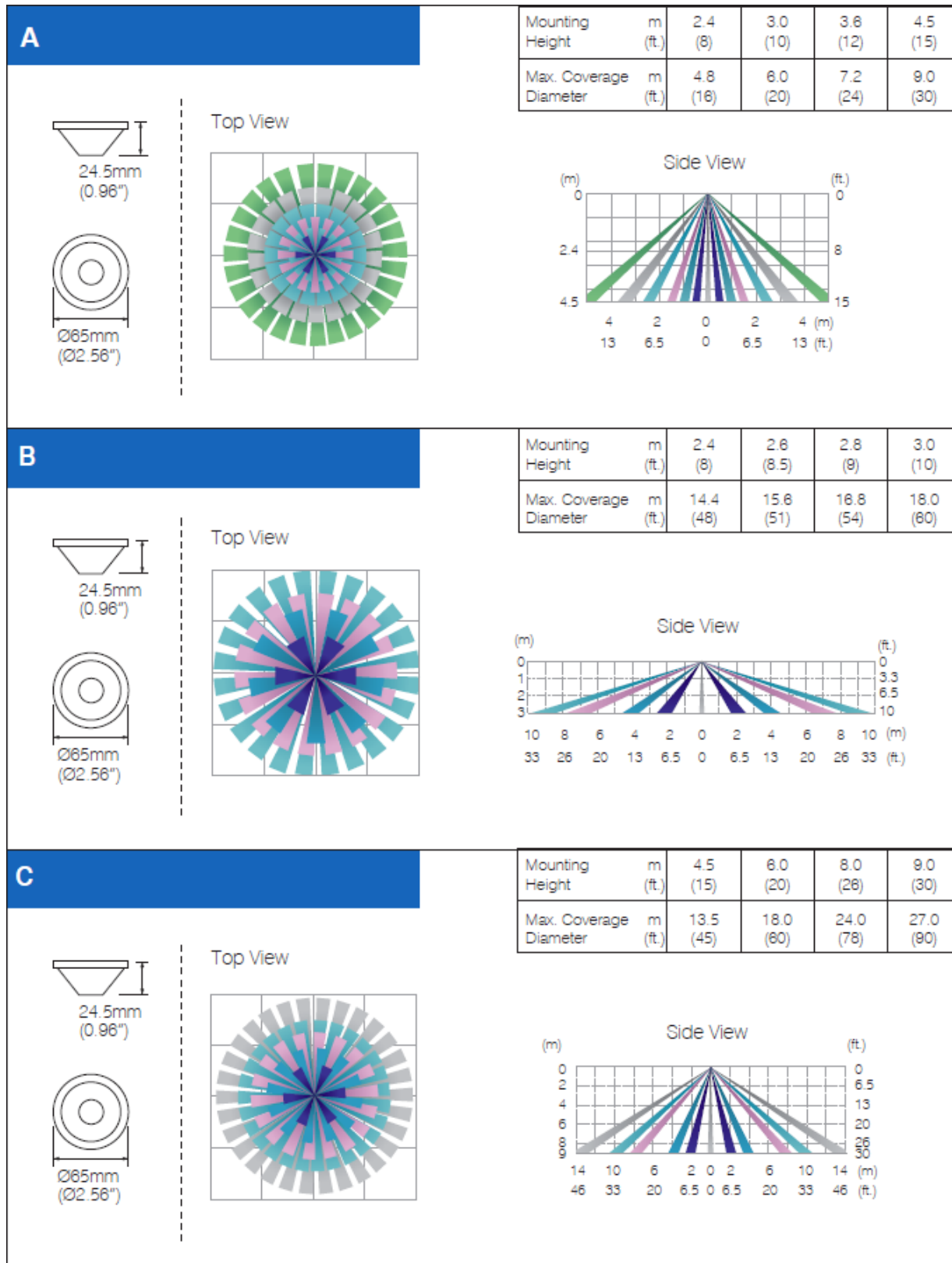

**D**

12mm  
(0.47")



Ø85mm  
(Ø2.56")

Top View

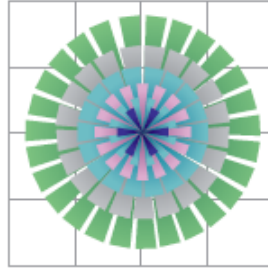

Mounting Height	m (ft.)	2.4 (8)	3.0 (10)	4.5 (15)	6.0 (20)
Max. Coverage Diameter	m (ft.)	4.8 (16)	6.0 (20)	9.0 (30)	12.0 (40)

Side View

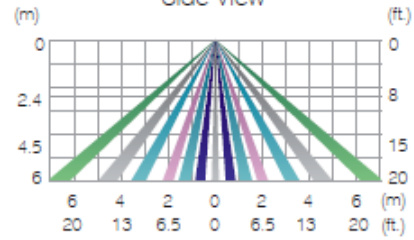
**F**

20mm  
(0.79")



Ø85mm  
(Ø2.56")

Top View

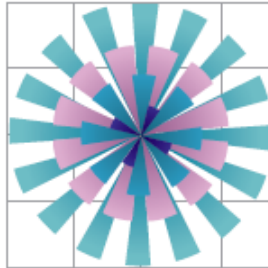

Mounting Height	m (ft.)	2.4 (8)	3.0 (10)	4.5 (15)	6.0 (20)
Max. Coverage Diameter	m (ft.)	9.6 (32)	12.0 (40)	18.0 (60)	24.0 (80)

Side View

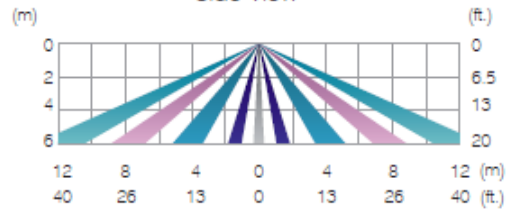
**G**

21mm  
(0.83")



Ø85mm  
(Ø2.56")



Top View

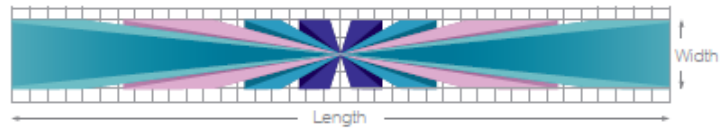

Mounting Height	m (ft.)	3.0 (10)	6.0 (20)	9.0 (30)	12.0 (40)
Max. Coverage Length x Width	m (ft.)	9.0 x 1 (30 x 3.3)	18.0 x 2 (60 x 6.5)	27.0 x 3 (90 x 10)	36.0 x 4 (120 x 13)

Side View

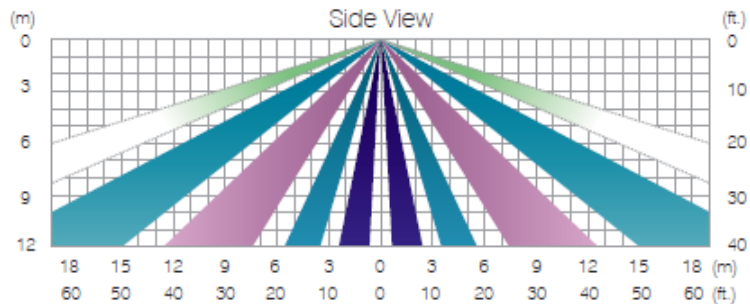

## ACCESSORIES

### LENS HOOD LH-110

The LH-110 is designed for bi-level control sensors to prevent its ambient light sensor from being saturated by the excessive lighting nearby.

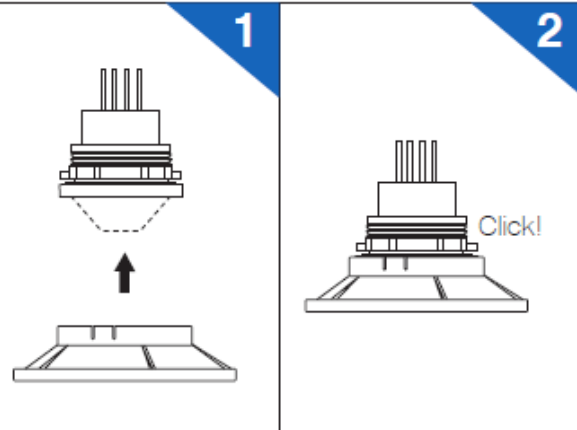
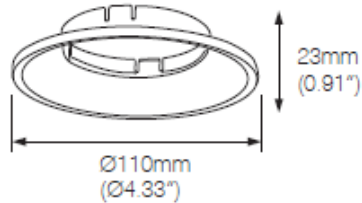

### LENS MASK

#### LM-12C For Lens A/B/C

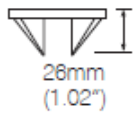

#### LM-12D For Lens F

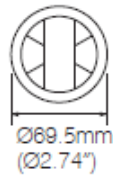
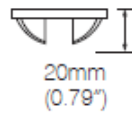

① Push the mask onto the installed lens



② Masked area can be changed by rotating the mask

#### Example: Lens F with LM-12D

Top View

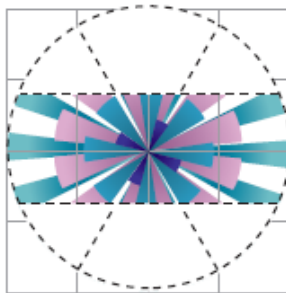

If necessary, the masked area can be altered by cutting off the respective grooved segments with a wire cutter or knife.



#### Coverage Area with Lens F and Mask

Mounting Height	m (ft.)	2.4 (8)	3.0 (10)	4.5 (15)	6.0 (20)
Max. Coverage Length x Width	m (ft.)	9.6 x 1 (32 x 3.3)	12.0 x 2 (40 x 6.5)	18.0 x 3 (60 x 10)	24.0 x 4 (80 x 13)

**Changes in  
versions**

12/2015 – Changed lens types (added type G, withdrew type E). Lens accessories were added.

10/2023 – Change of the logo