

Data sheet | Item number: w750-1400

16-channel digital input; 24 V DC; 3 ms; Ribbon cable; light gray

<https://domat-int.com/en/downloads/data-sheets>

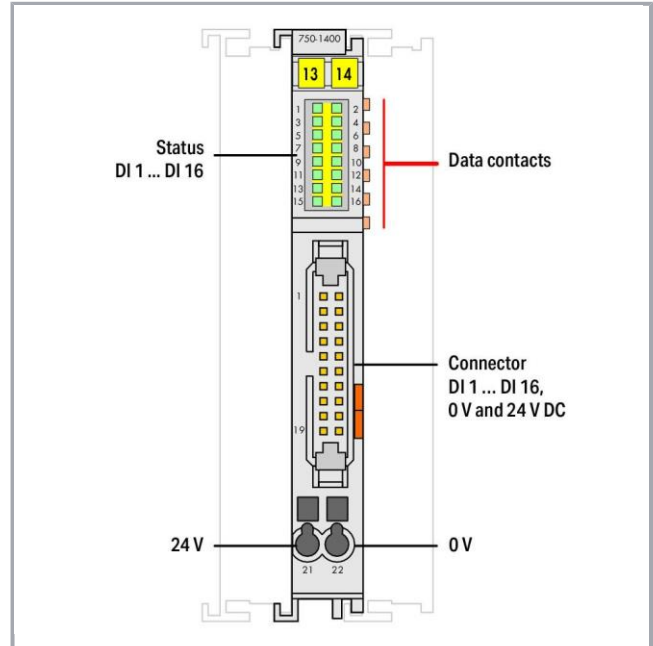
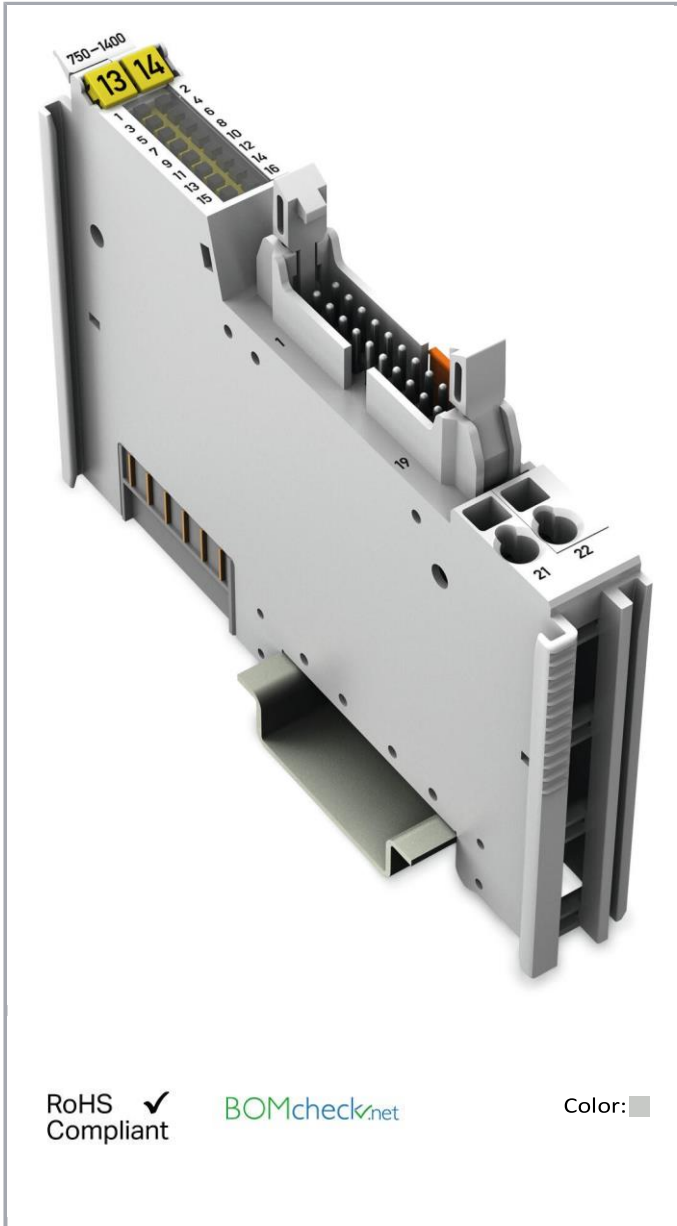

RoHS Compliant

BOMcheck.net

Color: ■

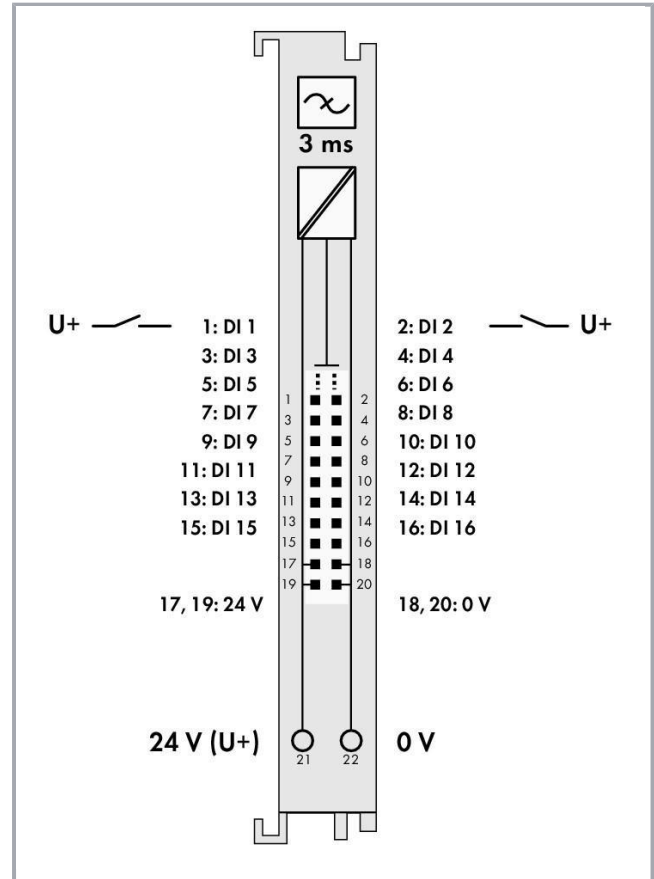
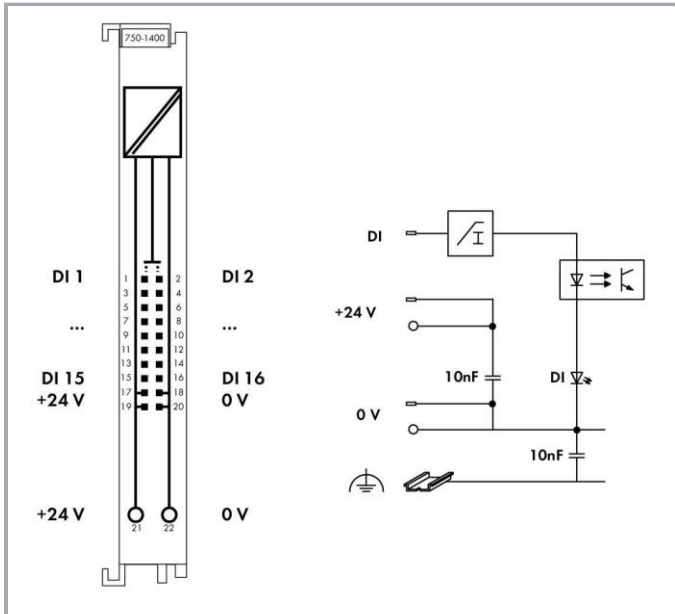

Item description

The digital input module provides sixteen channels in a width of just 12 mm (0.47 inch).

It receives binary control signals from digital field devices (e.g., sensors, encoders, switches or proximity switches).

The module connects electronic modules via a 20-pole flat cable.

The 24V power is fed to the electronic modules via two CAGE CLAMP® terminals.

Each input channel has a noise-rejection RC filter with 3.0 ms time constant.

A green LED indicates the switched status of each channel. Field and system levels are electrically isolated.

Technical data

Number of digital inputs	16
Total number of channels (module)	16
Type of signal	Voltage
Type of signal voltage	DC 24 V
Sensor supply voltage	DC 24 V
Sensor connection	16 × (1-conductor)
Input characteristic	High-side switching
Input filter (digital)	3 ms
Input current per channel for signal (0) typ.	0.6 mA
Input current per channel for signal (1) min.	2.1 mA
Input current per channel for signal (1) max.	2.4 mA
Voltage range for signal (0)	-3 ... +5 VDC
Voltage range for signal (1)	15 ... 30 VDC
Max input data width (internal)	16 Bit
System supply voltage	DC 5 V; via data contacts
Current consumption, system supply (5 V)	25 mA
Field supply voltage	DC 24 V (-25 ... +30 %); via wiring level (CAGE CLAMP® connection)
Isolation	500 V system/supply
Indicators	LED (1-16) green: Status DI 1 ... DI 16

Connection data

Connection technology: In-/Outputs	20 × 20-pin male connector
Connection technology: field supply	2 × CAGE CLAMP®
Connection type (1)	Inputs/Outputs
Connection type (2)	Field supply
Solid conductor (2)	0.08 ... 2.5 mm ² / 28 ... 14 AWG
Fine-stranded conductor (2)	0.08 ... 2.5 mm ² / 28 ... 14 AWG
Strip length (2)	8 ... 9 mm / 0.31 ... 0.35 inch

Geometrical Data

Width	12 mm / 0.472 inch
Height	74.1 mm / 2.917 inch
Height from upper-edge of DIN-35 rail	66.9 mm / 2.634 inch
Depth	100 mm / 3.937 inch

Mechanical data

Type of mounting	DIN-35 rail
------------------	-------------

Material Data

Color	Light gray
Housing material	Polycarbonate, polyamide 6.6
Fire load	1.057 MJ
Weight	41.7 g
Conformity marking	CE

Environmental Requirements



Surrounding air (operating) temperature	0 ... 55 °C
Surrounding air (storage) temperature	-40 ... 85 °C
Protection class	IP20
Degree of pollution (5)	2 per IEC 61131-2
Operating altitude	0 ... 2000 m
Mounting position	Horizontal (standing/lying) or vertical
Relative air humidity (no condensation)	95 %
Vibration resistance	4 g per IEC 60068-2-6
Shock resistance	15 g per IEC 60068-2-27
EMC immunity to interference	Acc. to EN 61000-6-2, marine applications
EMC emission of interference	Acc. to EN 61000-6-3, marine applications
Exposure to pollutants	Acc to IEC 60068-2-42 and IEC 60068-2-43
Permissible H ₂ S contaminant concentration at a relative humidity 75 %	10 ppm
Permissible SO ₂ contaminant concentration at a relative humidity 75 %	25 ppm

Commercial data

Product Group	15 (Remote I/O)
Packaging type	BOX
Country of origin	DE
GTIN	4045454880590
Customs Tariff No.	85389099990

Approvals / Certificates

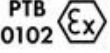



Ex-Approvals

Logo	Approval	Additional Approval Text	Certificate name
	ATEX TUEV Nord Cert GmbH	EN 60079-0	TÜV 07 ATEX 554086 X en.
	TUEV Nord TUEV Nord Cert GmbH	IEC 60079-0	IECEX TUN 09.0001 X

Country specific Approvals

Logo	Approval	Additional Approval Text	Certificate name
	KC National Radio Research Agency	Article 58-2, Clause 3	MSIP- REM- W43DIM750

Ship Approvals



Logo	Approval	Additional Approval Text	Certificate name
	ABS American Bureau of Shipping	-	19- HG1821926
	BV Bureau Veritas S.A.	-	30389/B0 BV
	DNV GL Det Norske Veritas, Germanischer Lloyd	-	TAA0000194
	KR Korean Register of Shipping	-	KR HMB05880AC001
	LR Lloyds Register	-	02/20026 (E6)



domat

MEMBER OF CEZ ESCO

Data sheet | Item number: w750-1400
<https://www.domat-int.com/en/data-sheets>

	NK Nippon Kaiji Kyokai	-	TA17255M
	PRS Polski Rejestr Statków	-	TE/2236 /880590/19
	RINA RINA Germany GmbH	-	ELE066419XG

UL-Approvals

Logo	Approval	Additional Approval Text	Certificate name
	UL UL International Netherlands B.V. (ORDINARY LOCATIONS)	UL 508	E175199 Sec.1

Subject to changes.

Domat control system

WAGO Kontakttechnik GmbH & Co. KG (manufacturer)

Do you have any questions about our products?

We are always happy to take your call at +420 461 100 666.