

order number

wCIOcom DDC controller



Summary

DDC (Direct digital control) controller wCIOcom is a compact PLC with Merbon RT. The controller contains two Ethernet ports, serial port and a datapoint mix of 8 AI, 8 DI, 8 AO and 8 DO. Besides network and fieldbus interfaces, the controller supports all analog, digital and special I/O modules within the 750/753 series.

Application

- Freely programmable control units for HVAC systems and other applications with web access.
- Data acquisition, processing, and presentation systems with advanced networking features.
- Protocol converters with web data presentation (must be programmed by user).

Function

The main unit has a twin-port Ethernet interface and thanks to its integrated switch it is able to connect more PLCs in a line topology.

Typical use of the PLC is in building control systems, industry and energy management systems.

- Programmable via Merbon IDE
- Direct connection of I/O modules
- 2x Ethernet (configurable)
- Operating system Linux
- Maintenance free / Low maintenance

The application is created and uploaded in the Merbon IDE development environment. The maximum application program size depends on number of physical and software data points, amount of function blocks which require more memory (e.g. time schedulers), degree of code optimisation, and number of connections the PLC has to handle.

IO modules (8 AI, 8 AO, 8 DI, 8 DO) communicate with the main unit over an internal K-bus.

The process station contains a web server for remote connection and user intervention. The web pages are created in Merbon HMI editor, which is included in the package of development programs. The exported web definition is uploaded to the process station through Merbon IDE.

State of inputs and outputs of each module, system status, runtime operation and power supply condition is indicated by LEDs.

Controller is to be mounted on standard DIN rail.

See *domat – Technical application notes* for connection examples.

Technical data

Power	24 V DC (-25...+30 %), 4 W, cage clamp type terminals
Operating temperature	0...55 °C
Max. admissible humidity	95 %
PLC:	
Type	750-8102
CPU	Cortex A8, 600 MHz
Memory	256 MB RAM, 64 kB NVRAM
Memory card	microSD up to 32 GB (push/push type slot, cover possible to seal)
Addressing	SW or by DIP switches
Communication:	
Ethernet	2 × Ethernet 10/100, RJ45 2 × signalling LEDs (Link, Data) part of the Ethernet connector
Serial port	RS232/485
Programming environment	Merbon IDE ver. 2:4:0:x or later (ST, FBD)
Terminals	cage clamp terminals - wire 0.08...2.5 mm ²
Analogue inputs	8 × Pt 1000, resistance 0...1200 Ohm, 0...5000 Ohm, 16 bit resolution (other measuring ranges, like Pt100, Ni1000 etc. can be recalculated using predefined transformations in the Merbon program) 8 × voltage 0...10 V DC / ±10 V DC, 12 bit resolution
Analogue outputs	8 × 0...10 / ±10 V DC
Load impedance	≥ 2 kΩ
Digital inputs	8 × 24 V DC – need to connect DC voltage, e.g. that from the power supply

Input voltage „log. 0“	max. 5 V DC, 1.6 mA
Input voltage „log. 1“	max. 30 V DC, 4.3...4.6 mA
Digital outputs	8 semiconductor, NO: 0.5 A /24 V DC, 1 kHz
Dimensions	71.9 (h) × 121.5 (w) × 100 (h) mm
Weight	approx. 380 g
Protection degree	IP20
Material	polycarbonate, polyamide 6.6
Standards conformity	electromagnetic compatibility (EMC)EN 61000-6-2, 61000-6-3 environmental testing EN 60068-2-42, 60068-2-43

Dimensions and connection

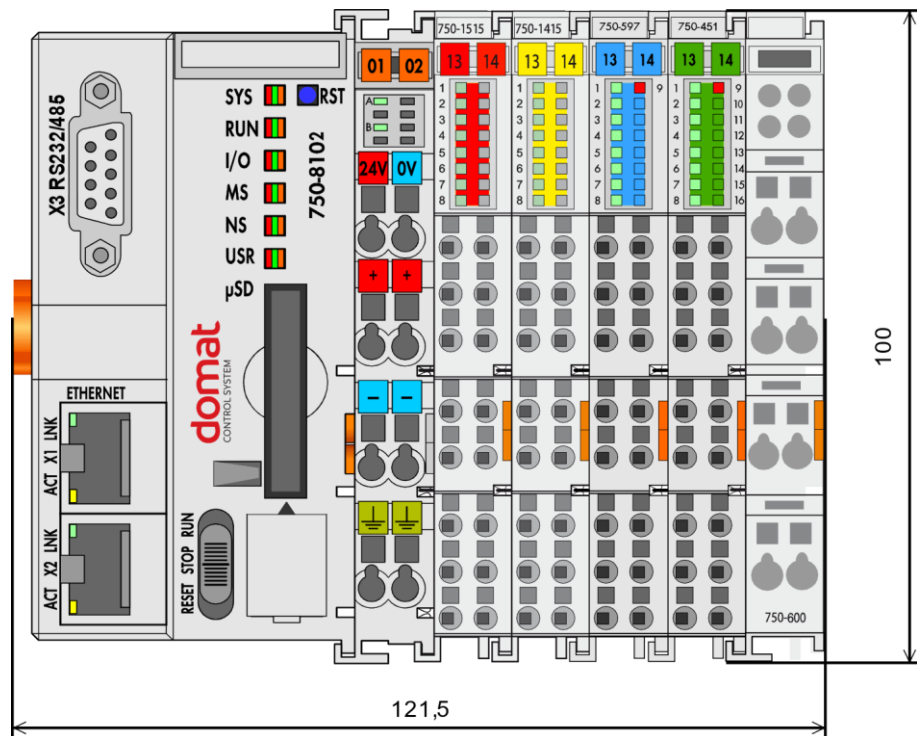

Dimensions are in *mm*.

For proper function of the controller assembly a **terminating module** 750-600 must be snapped at the end of assembly. All modules must be aligned.

To ensure power supply for the connected I/O modules, it is required to connect the **24V** and **0V** terminals on the power module (see image below).

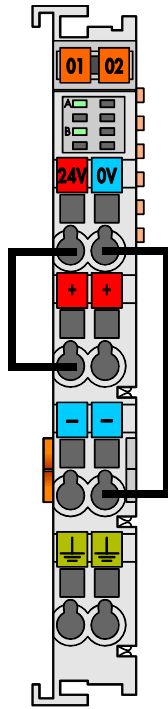

During the installation, ensure sufficient distance of controller assembly from other components:

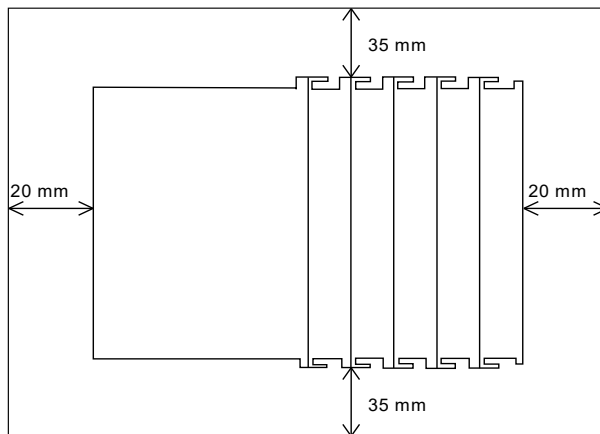

Serial port

wCIOcom controller has serial interface with Cannon 9F connector, which can be used as RS-232 or as RS-485. This can be set in Merbon IDE.

Voltage levels for RS-232 and RS-485 are different!
Ensure correct setting and connection.

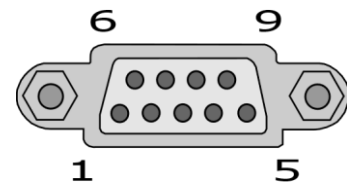

Pin	RS-232		RS-485	
	RS-232	RS-232	RS-485	RS-485
1	NC	Not assigned	NC	Not assigned
2	RxD (out)	Receive data	NC	Not assigned
3	TxD (in)	Transmit data	A (Tx/Rx+)	Transmit/receive data +
4	NC	Not assigned	NC	Not assigned
5	FB_GND	Ground	FB_GND	Ground
6	NC	Not assigned	FB_5V	Power supply
7	RTS (in)	Request to send	NC	Not assigned
8	CTS (out)	Clear to send	B (Tx/Rx-)	Transmit/receive data -
9	NC	Not assigned	NC	Not assigned
Enclosure	Shield	Shielding	Shield	Shielding

For connection of GSM modem to build-in RS232 port the null-modem M-M cable (2-3, 3-2, 5-5) should be used.

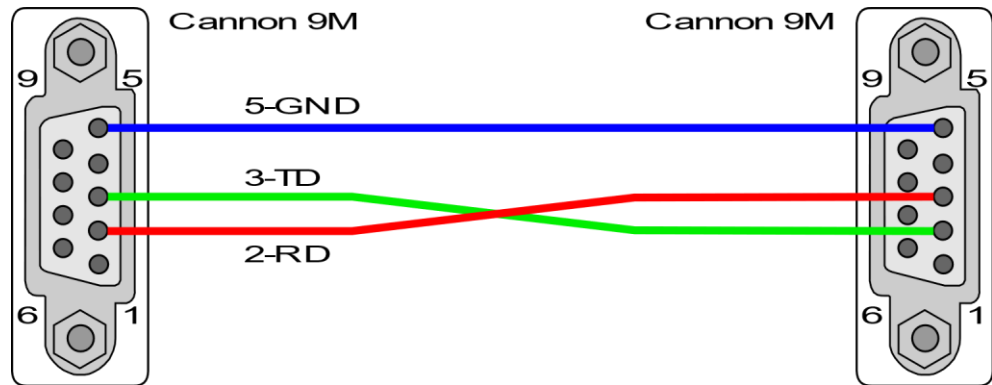

Controller is made from PLC: [PFC100 \(750-8102\)](#) and modules: [750-1515](#), [750-1415](#), [750-597](#), [750-451](#) a [750-600](#).

Analogue inputs

Analogue input module **750-451** has fixed resistance measurement at 8 inputs. See connection scheme (two-wire connection):

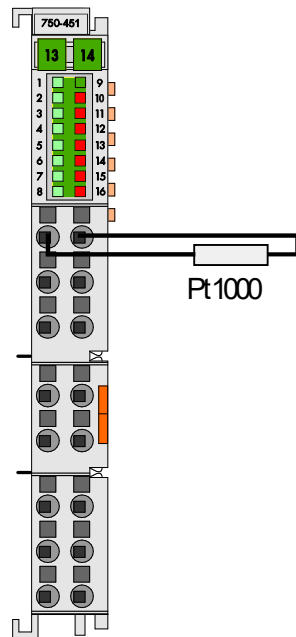

Operational readiness and trouble-free data bus communication of each input is **indicated** by green LED. Red LED indicates wire break, short circuit or signal out of its measuring range. For accuracy of measurement see table in complete specification datasheet.

Complete specification of module is stated in particular datasheet: [w750-451](#)

Analogue outputs

Analogue output module **750-597** (8 AO) provides 0...10 V DC output. The output signal is galvanically insulated, with resolution of 12 bits. Measurement error is 0.1 % from the measuring range. All outputs have common ground M (terminals 9...16), which is connected to the module minus terminal by common contact.

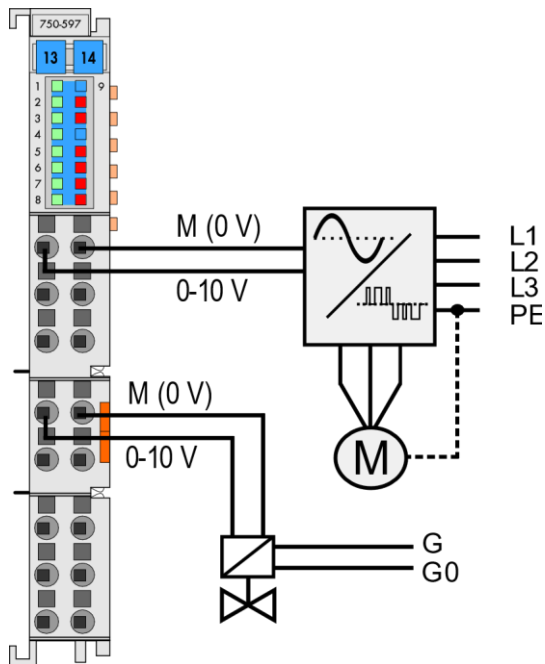

Operational readiness and trouble-free data bus communication of each channel is **indicated** by green LED. Red LED indicates status of the field power supply voltage (undervoltage or general error).

Complete specification of module is stated in particular datasheet:

[w750-597](#)

Digital inputs

Digital inputs module **750-1415** has 8 input channels (24 V DC, 3 ms) and operate with 24 V DC voltage. This voltage is brought to the terminals 9...16. Inputs are galvanically separated from the other modules or controller and can be powered by controller power supply. Voltage levels are -3 V...+5 V for False and +11 V...+30 V for True.

Digital inputs are connected according to this scheme (two-wire connection):

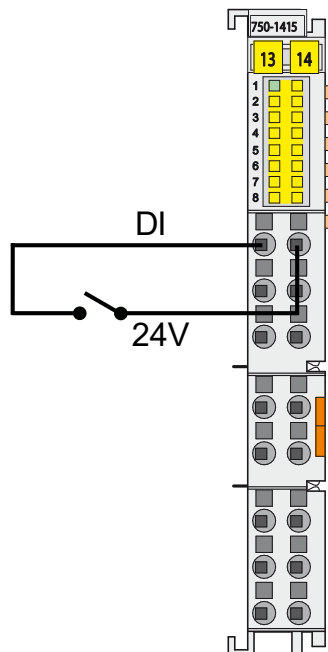

Active state of each input is **indicated** by green LED (on = logical one detected).

Complete specification of module is stated in particular datasheet:

[w750-1415](#)

Digital outputs Digital outputs module **750-1515** has 8 output channels (24 V DC, 0.5 A, short-circuit protected, 1 kHz). See scheme below for connection:

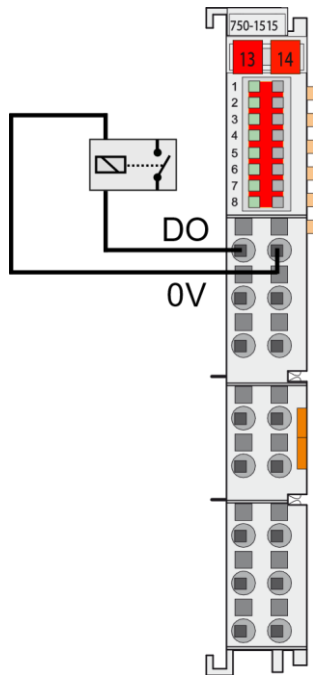

Switched status of each output is indicated by a green LED in the upper part of the module.

Complete specification of module is stated in particular datasheet:

[w750-1515](#)

LED indication

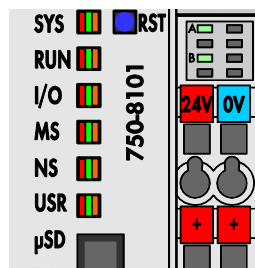

Red/ green/ orange LED (blink):
 SYS – system status
 RUN – runtime is running
 I/O – bus status (not used)
 MS – module status (not used)
 NS – not used
 USR – user programmable
 green LED:
 μSD – SD card status (blinks during writing on card)
 A – state of supply voltage (still)
 B – state of I/O modules supply voltage (still)

Switches

RST
RESET STOP RUN



Reset button - unused
 Switch in RUN position starts the runtime. Turning the switch in STOP position stops the runtime. In this position it is not possible to deploy and run solution.
 Holding switch in the RESET position for 2-7 seconds causes warm restart. Holding RESET for longer than 7 seconds invokes cold restart.

Address SW address

Others

Internal K-bus addressing

For each module a position corresponding to the physical position in assembly is given to the module. E.g. first module after controller gets adress 1, etc.

Slot for SD card is for production purposes only, not intended to be used by user.

For proper function of the controller assembly a **terminating module** 750-600 must be snapped at the end of assembly. All modules must be aligned.

To ensure power supply for the connected I/O modules, it is required to connect the **24V** and **+**, **0V** and **-** terminals on the power module (see image in *Dimensions and connection*).

You can find complete specification of each device at www.wago.com.

Programming

The main programming tool is the Merbon package which contains I/O editor, graphical editor of the function plan (FBD), structure text editor and compiler (Merbon IDE). The Merbon package contains also LCD menu editor as well as web editor (Merbon HMI).

The application program consists of function blocks which are stored in libraries. Those contain analogue and digital functions, mathematical blocks including goniometric functions, time schedulers, alarm blocks, and HVAC specific blocks (heat recovery, dewpoint calculation, enthalpy, pump switch etc.). The program can be set up also as structure text (ST) or with combination of both types of programming languages.

In case of implementation of your own ST driver, there is limitation of max. 10 clients connected simultaneously.

Number of connections from SSCP clients is max. 20. This includes connections from Merbon IDE, Merbon SCADA, HT104/200, mobile application Merbon Visual, connection from other PLCs over SSCP etc.

Uploading a project from the Merbon IDE reserves two SSCP TCP connections.

Accessories

Mini-WSB marking card (247-513)

- snap-on type
- horizontal markings of each module

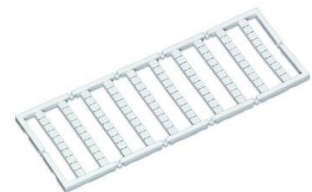

Fieldbus connector PROFIBUS (750-960)



Safety note

The device is designed for monitoring and control of heating, ventilation, and air conditioning systems. It must not be used for protection of persons against health risks or death, as a safety element, or in applications where its failure could lead to physical or property damage or environmental damage. All risks related to device operation must be considered together with design, installation, and operation of the entire control system which the device is part of.

**Changes in
versions**

01/2020 – First datasheet version.

12/2021 – GSM modem connection to RS232 info added, Styl

02/2022 – Logo change, stylistic modifications, added information about limiting the number of connected clients.

03/2022 – Modified number of simultaneously connected clients using the SSCP protocol.

05/2022 – Memory size update.

08/2022 – Stylistic modifications (list of modules, order number).