

Data sheet | Item number: w750-459
 4-channel analog input; 0 ... 10 VDC; Single-ended; light gray
<https://www.domat-int.com/en/data-sheets>



RoHS  Compliant

BOMcheck.net

Color: 

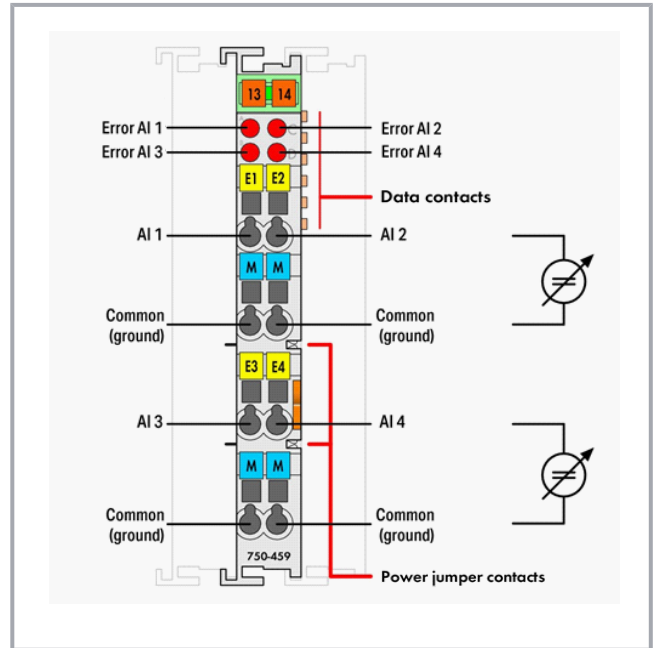

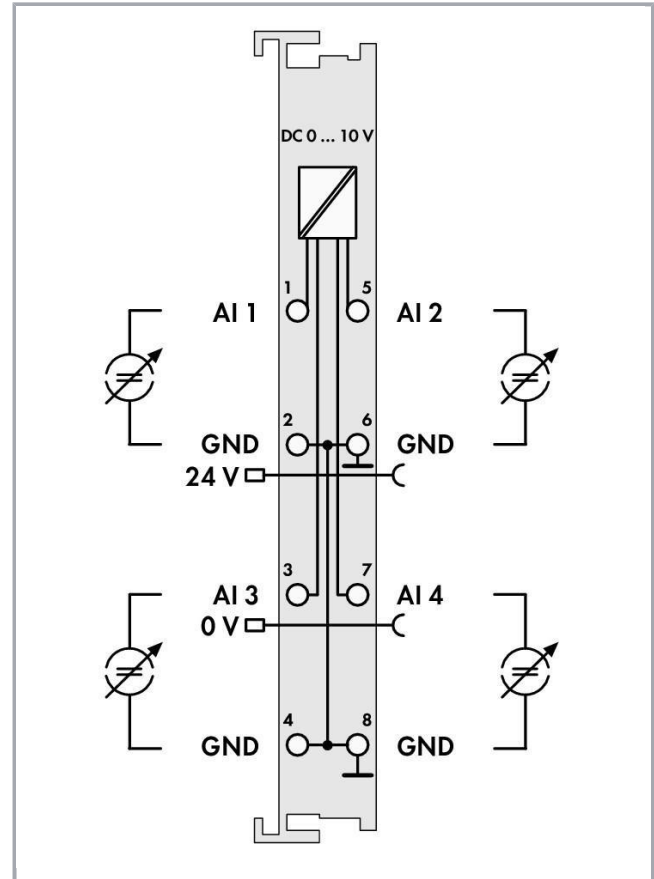
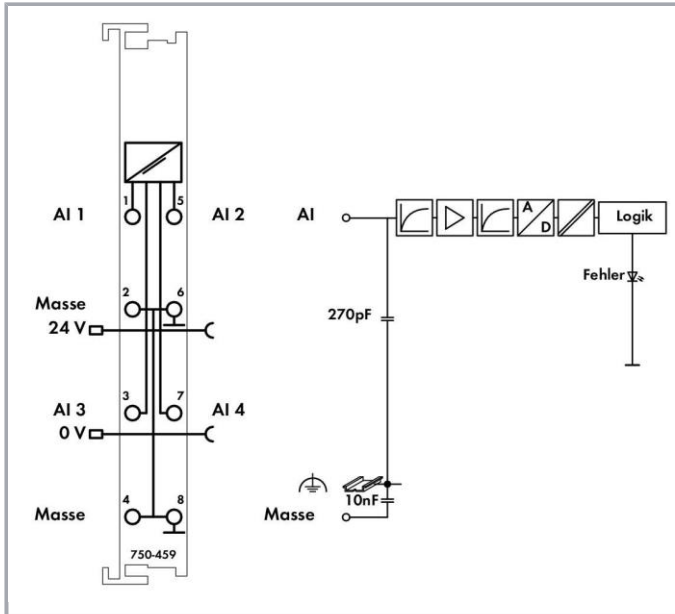

Item description

The analog input module processes signals of a standard magnitude 0 ... 10V.

The input signal is electrically isolated and is transmitted with a resolution of 12 bits.

The internal system supply powers the module.

The input channels of the module have one common ground potential.

Technical data

Number of analog inputs	4
Total number of channels (module)	4
Type of signal	Voltage
Type of signal voltage	DC 0 ... 10 V
Sensor connection	4 × (2-conductor)
Input voltage (max.)	±40 V
Signal characteristic	Single-ended
Resolution [bit]	12 Bit

Bit width	4 × 16-bit data; 4 × 8-bit control/status (optional)
Internal resistance	100 kΩ
Conversion time (typ. ≤)	10 ms
Reference temperature	25 °C
Deviation max.	0.1 %
Temperature error max.	0.01 %/K
System supply voltage	DC 5 V; via data contacts
Current consumption, system supply (5 V)	65 mA
Field supply voltage	DC 24 V (-25 ... +30 %); via power jumper contacts (power supply via blade contact; transmission via spring contact)
Isolation	500 V system/supply
Number of incoming power jumper contacts	2
Number of outgoing power jumper contacts	2

Connection data

Connection technology: In-/Outputs	8 × CAGE CLAMP®
Connection type (1)	Inputs/Outputs
Solid conductor	0.08 ... 2.5 mm ² / 28 ... 14 AWG
Fine-stranded conductor	0.08 ... 2.5 mm ² / 28 ... 14 AWG
Strip length	8 ... 9 mm / 0.31 ... 0.35 inch

Geometrical Data

Width	12 mm / 0.472 inch
Height	69.8 mm / 2.748 inch
Height from upper-edge of DIN-35 rail	62.6 mm / 2.465 inch
Depth	100 mm / 3.937 inch

Mechanical data

Type of mounting	DIN-35 rail
------------------	-------------

Material Data

Color	Light gray
Housing material	Polycarbonate, polyamide 6.6
Fire load	1.504 MJ
Weight	50.8 g
Conformity marking	CE

Environmental Requirements



Surrounding air (operating) temperature	0 ... 55 °C
Surrounding air (storage) temperature	-40 ... 85 °C
Protection class	IP20
Degree of pollution (5)	2 per IEC 61131-2
Operating altitude	0 ... 2000 m
Mounting position	Horizontal (standing/lying) or vertical
Relative air humidity (no condensation)	95 %
Vibration resistance	4 g per IEC 60068-2-6
Shock resistance	15 g per IEC 60068-2-27
EMC immunity to interference	Acc. to EN 61000-6-2, marine applications
EMC emission of interference	Acc. to EN 61000-6-4, marine applications
Exposure to pollutants	Acc. to IEC 60068-2-42 and IEC 60068-2-43
Permissible H ₂ S contaminant concentration at a relative humidity 75 %	10 ppm
Permissible SO ₂ contaminant concentration at a relative humidity 75 %	25 ppm

Commercial data

Product Group	15 (Remote I/O)
Packaging type	BOX
Country of origin	DE
GTIN	4045454471507
Customs Tariff No.	85389099990

Approvals / Certificates

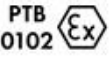





Ex-Approvals

Logo	Approval	Additional Approval Text	Certificate name
	ATEX TUEV Nord Cert GmbH	EN 60079-0	TÜV 07 ATEX 554086 X en.
	TUEV Nord TUEV Nord Cert GmbH	IEC 60079-0	IECEX TUN 09.0001 X

Country specific Approvals

Logo	Approval	Additional Approval Text	Certificate name
	KC National Radio Research Agency	Article 58-2, Clause 3	MSIP- REM-W43AIM750

Ship Approvals

Logo	Approval	Additional Approval Text	Certificate name
	ABS American Bureau of Shipping	-	19- HG1821926
	BV Bureau Veritas S.A.	-	13453/DO BV
	DNV GL Det Norske Veritas, Germanischer Lloyd	-	TAA0000194
	KR Korean Register of Shipping	-	KR HMB05880AC001
	LR Lloyds Register	-	02/20026 (E6)
	NK Nippon Kaiji Kyokai	-	TA17255M
	PRS Polski Rejestr Statków	-	TE/2236 /880590/19



RINA
RINA Germany GmbH

ELE066419XG

UL-Approvals

Logo	Approval	Additional Approval Text	Certificate name
	UL UL International Netherlands B.V. (ORDINARY LOCATIONS)	UL 508	E175199 Sec.1

Subject to changes.

Domat control system

WAGO Kontakttechnik GmbH & Co. KG (manufacturer)

Do you have any questions about our products?

We are always happy to take your call at +420 461 100 666.